

# TOSHIBA

## OWNER'S MANUAL

2.4GHz DIGITAL SPREAD SPECTRUM CORDLESS TELEPHONE

# SG-1600

# SG-1800



The **FIRST** thing to do after unpacking your new cordless telephone is:

**CHARGE THE BATTERY !**

Please read and follow the few instructions on

**PAGE 2**

**BEFORE YOU DO ANYTHING ELSE.**

Preparation

Basics

Caller ID/Call waiting

Additional Information

# GETTING STARTED: DO THIS FIRST!

## **FIRST,**

- **Before you can take advantage of the Caller ID and Call Waiting features, you must subscribe to these services from your local telephone company.**
- Name and number caller ID only work in conjunction with service provided by your local telephone company.

## **SECOND,** after unpacking your new cordless phone:

### **CHARGE THE HANDSET BATTERY!**

- **Set your new phone in an out-of-the-way place near a power outlet where it will not be disturbed.**
- Plug the AC adaptor into the wall outlet.
- Plug the AC adaptor cord into the power jack on the base unit.
- Take the cover off the handset battery compartment; plug the battery connector into the receptacle inside the battery compartment and replace the cover. The connector only goes in one way.
- Place the handset into the base unit's charging cradle. The IN USE/CHARGE LED should light. If not, see TROUBLESHOOTING, page 36.
- The battery charging period has now started. From now until the 12-16 hour period is complete, do not let anything cause the handset to be removed from electrical contact with the base unit's charging pins or power to be removed from the base unit.

**THIRD,** Enter your AREA CODE, see page 16.

# TABLE OF CONTENTS

---

## ***Preparation***

IMPORTANT SAFETY INSTRUCTIONS .....	5
INTRODUCTION .....	7
Features .....	7
Parts identification .....	8
LOCATION OF CONTROLS .....	9
Handset .....	9
Base unit .....	9
INSTALLATION .....	10
Setting up the base unit (Desk top mounting) .....	10
Setting up the base unit (Wall mounting) .....	11
Charging the battery pack .....	12
Setting the Tone/Pulse switch .....	14
Setting or cancelling the Auto Talk function .....	14
Setting or cancelling caller ID on call waiting .....	15
Setting the area code .....	16
Carrying the handset in the Belt clip .....	17
Using a headset .....	17

## ***Basics***

BASIC OPERATION .....	18
Making a call .....	18
Answering a call .....	19
Out of range .....	19
Call waiting .....	19
Changing the ringer volume .....	20
Changing the handset speaker volume .....	20
3 number redial .....	21
Sending the tone signal .....	21
Paging the handset .....	22
Interference or static .....	22

# TABLE OF CONTENTS

---

MEMORY DIALING .....	.23
Storing numbers .....	.23
Dialing a stored number .....	.25
Changing and deleting stored numbers .....	.26

## ***Caller ID/Call waiting***

CALLER ID/CALL WAITING .....	.28
Answering a call with caller ID service .....	.28
Call Waiting .....	.29
Searching caller ID memory .....	.30
Dial out .....	.31
Editing caller ID data .....	.32
Storing to speed dial memory .....	.33
Deleting caller ID data .....	.34

## ***Additional Information***

TROUBLESHOOTING .....	.36
WARRANTY/SERVICE .....	.38
WALL MOUNT TEMPLATE .....	.33

# IMPORTANT SAFETY INSTRUCTIONS

When using your telephone equipment, basic safety precautions should always be followed to reduce the risk of fire, electric shock and injury.

- 1 Read and understand all instructions.
- 2 Follow all warnings and instructions marked on the product.
- 3 Unplug this product from the wall outlet before cleaning. Do not use liquid cleaners or aerosol cleaners. Use a dry cloth for cleaning.
- 4 Do not use this product near water sources, such as bath tubs, wash bowls, kitchen sinks, laundry tubs, wet basements, or swimming pools.
- 5 Do not place this product on an unstable cart, stand, or table. The telephone may fall, causing serious damage to the telephone.
- 6 Slots and openings in the cabinet and the back or bottom are provided for ventilation. To protect it from overheating, these openings must not be blocked or covered. The openings should never be blocked by placing the product on a bed, sofa, rug, or other similar surface. This product should never be placed near or over a radiator or heat register. This product should not be placed in a built-in installation unless proper ventilation is provided.
- 7 Do not allow anything to rest on the power cord. Do not locate this product where the cord can be stepped on or tripped over.
- 8 Do not overload wall outlets and extension cords as this can result in the risk of fire or electric shock.
- 9 Never push objects of any kind into this product through cabinet slots as they may touch dangerous voltage points or short out parts that could result in a risk of fire or electric shock. Never spill liquid of any kind on the product.
- 10 Do not disassemble this product. Opening or removing covers puts you at risk of electrical shock, and incorrect reassembly can cause shocks, sparks or other damage during subsequent use.
- 11 Take this product to a qualified service technician under any of the following conditions:
  - A. When the power supply cord is damaged or frayed.
  - B. If liquid has been spilled into the product.
  - C. If the product has been exposed to rain or water.
  - D. If the product does not operate normally according to the operating instructions. Adjust only those controls covered by this manual. Improper adjustment of other controls may result in serious damage to the unit or your home.
  - E. If the product has been dropped or the cabinet has been damaged.
  - F. If the product exhibits a distinct change in performance.
- 12 Do not use the telephone in the vicinity of a gas leak.

# IMPORTANT SAFETY INSTRUCTIONS

## The RBRC™ Seal



The RBRC™ Seal on the (easily removable) nickel-cadmium battery (contained in our product) indicates that Toshiba America Consumer Products, Inc. (TACP) is voluntarily participating in an industry program to collect and recycle these batteries at the end of their useful lives, when taken out of service within the United States. The RBRC™ program provides a convenient alternative to placing used nickel-

cadmium batteries into the trash or municipal waste, which is illegal in some areas.

TACP's payments to RBRC™ make it easy for you to drop off the spent battery at local retailers of replacement nickel-cadmium batteries, or at authorized TACP product service centers. You may also contact your local recycling center for information on where to return the spent battery. Please call 1-800-8-BATTER for information on Ni-Cd battery recycling in your area. TACP's involvement in this program is part of its commitment to protecting our environment and conserving natural resources.

RBRC™ is a trademark of Rechargeable Battery Recycling Corporation.

**CAUTION: TO REDUCE THE RISK OF FIRE OR INJURY TO PERSONS BY THE BATTERY, READ AND FOLLOW THESE INSTRUCTIONS.**

## BATTERIES

- 1 Use only the appropriate type and size battery pack specified in the instruction manual provided for this product.
- 2 Do not dispose of the battery pack in a fire. The cell may explode. Check with State and local codes for possible special disposal instructions.
- 3 Do not open or mutilate the battery pack. Released electrolytes are corrosive and may cause damage to the eyes or skin. It may be toxic if swallowed.
- 4 Exercise care in handling the batteries. Contact with conductive materials such as rings, bracelets and keys may cause the battery to short out, resulting in overheating which could burn.
- 5 Charge the battery pack provided with or identified for use with this product only in accordance with the instructions and limitations specified in the instruction manual provided for this product.
- 6 Observe proper polarity orientation between the battery pack and the battery charger.

**ATTENTION: THE PRODUCT THAT YOU HAVE PURCHASED CONTAINS A RECHARGEABLE BATTERY. UNDER VARIOUS STATE AND LOCAL LAWS, IT MAY BE ILLEGAL TO DISPOSE OF THIS BATTERY INTO THE MUNICIPAL WASTE STREAM. PLEASE CHECK WITH YOUR LOCAL GOVERNMENT FOR DETAILS IN YOUR AREA REGARDING RECYCLING OPTIONS OR PROPER DISPOSAL.**

## SAVE THESE INSTRUCTIONS

TO HELP PROTECT THE ENVIRONMENT, THIS PRODUCT MAY CONTAIN RECYCLED OR RECONDITIONED PARTS AND MATERIALS.

# INTRODUCTION

## FEATURES

Toshiba America Consumer Products, Inc., takes pride in presenting the SG-1600/1800 digital spread spectrum cordless telephone. The Toshiba SG-1600/1800 handset features a 16-digit x 3-line dot matrix liquid crystal display (LCD) for caller ID on Call Waiting and speed dial programming and calling. The sleek new design provides face-up battery charging even when wall mounted. Other features are summarized below.



- 2.4GHz digital spread spectrum transmission with extended talk range
- 30-channel auto scanning
- 50 name & number Caller ID - only works in conjunction with service provided by your local telephone company
- Caller ID on Call Waiting is available if both services are subscribed to and provided by your local telephone company
- Digital call protect privacy scrambling and digital security code
- Backlit 3-line alphanumeric LCD display
- Volume control (4 level)
- Ringer volume and tone control
- 20 speed dial (20 digits)
- Long standby battery life (7 days)
- One way page/Handset locator
- 3 number redial (32 digits)
- Any-key answer
- Hearing aid compatible/HAC volume
- Desk/Wall mountable (Bracket included)
- Headset jack

# INTRODUCTION

---

## PARTS IDENTIFICATION



**Handset**

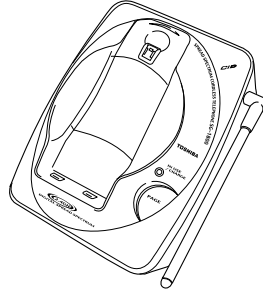

**Base Unit**

---

## SUPPLIED ACCESSORIES:

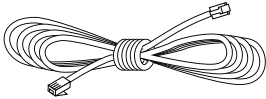

**Modular Line Cord**  
Part #.RC008231

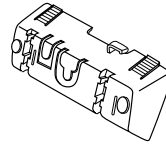

**Wall Mount Bracket**  
Part #.RC009262

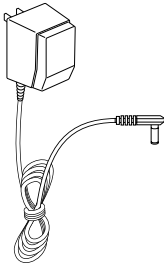

**AC Adaptor**  
TAC-1700  
Part #.RC009258

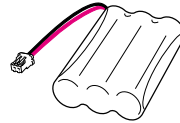

**Rechargeable Battery Pack**  
Toshiba TRB-8000  
Part #.RC004931



**Belt Clip**  
Part #.RC009263

**Owner's manual**  
Part #.RC009260

**Quick Reference Guide**  
Part #.RC009261

For purchase of accessories, please call 1-877-644-7373.



# LOCATION OF CONTROLS

## HANDSET

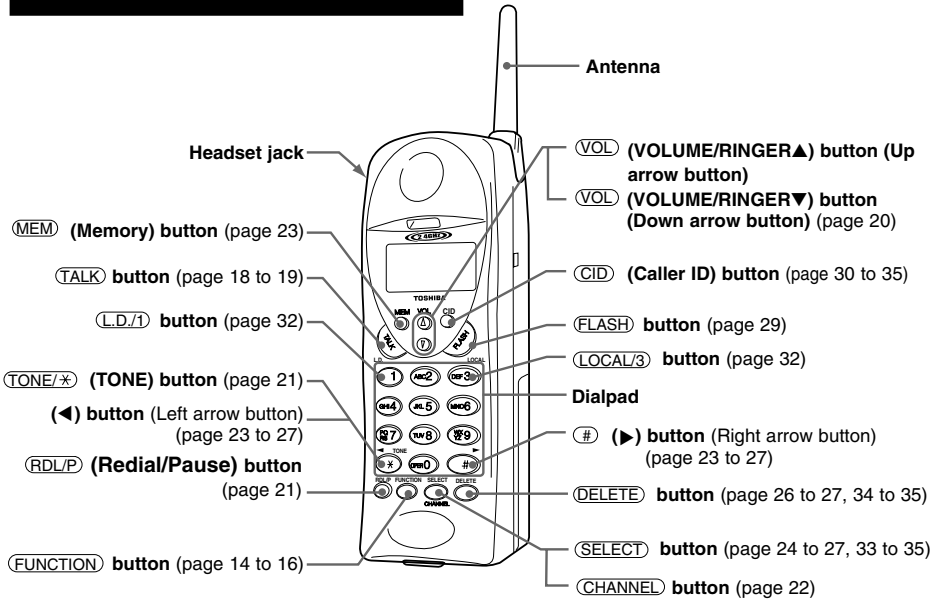

## BASE UNIT

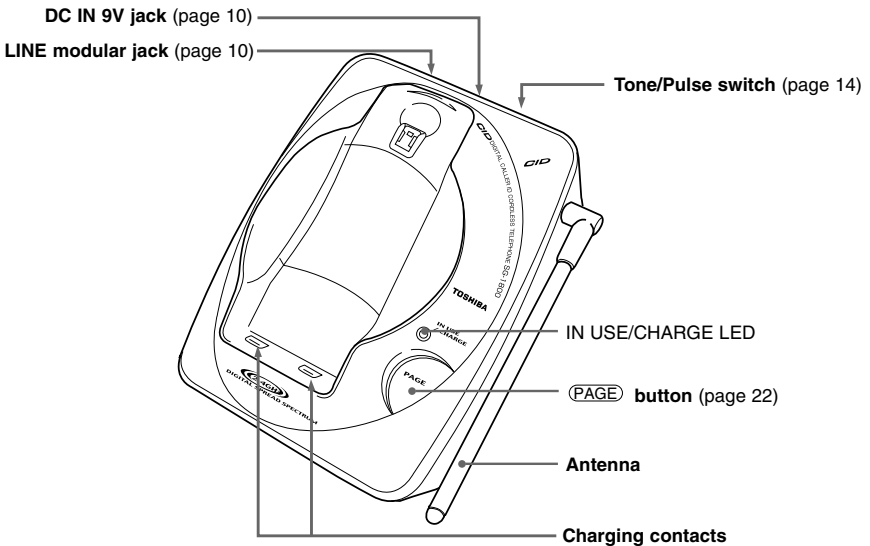

# INSTALLATION

## SETTING UP THE BASE UNIT (DESK TOP MOUNTING)

For setting up the base unit follow the instructions below.

Snap the bracket's tab into the notches on the base.

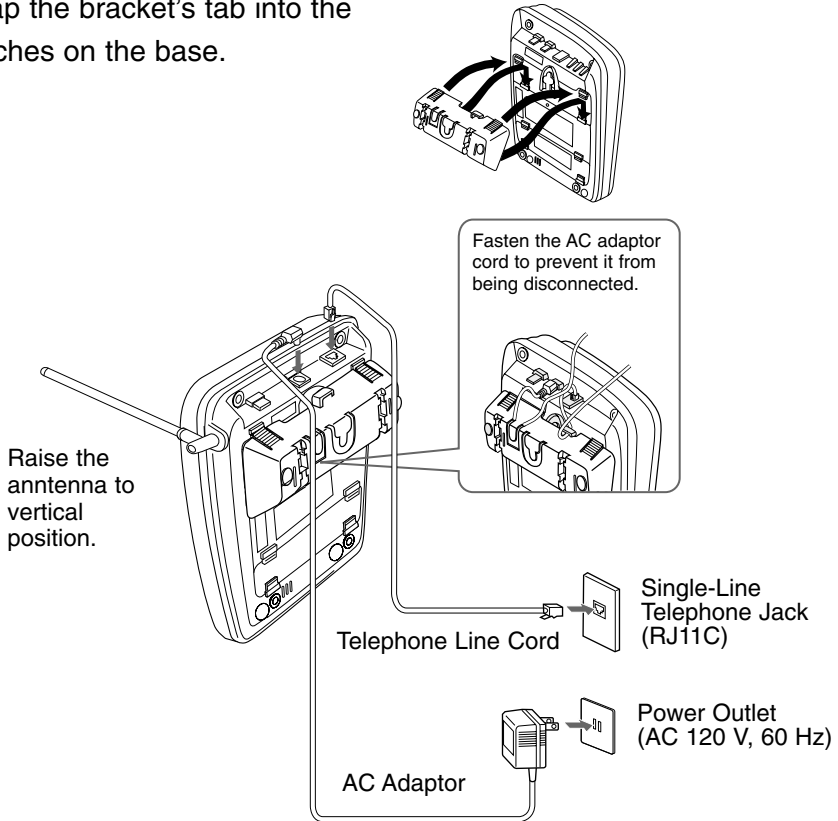

- USE ONLY WITH Supplied AC ADAPTOR (TAC-1700; power source AC 120V 60Hz/DC9V).
- The AC adaptor must remain connected at all times. (It is normal for the adaptor to feel warm during use).

# INSTALLATION

## SETTING UP THE BASE UNIT (WALL MOUNTING)

### MOUNTING ON A STANDARD WALL PLATE:

Insert the bracket's tabs into the base's lower tab slots, then press down on the top of the bracket to snap it into the clip slots.

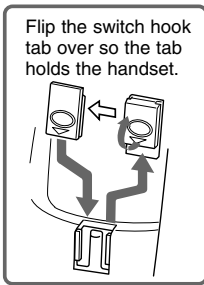
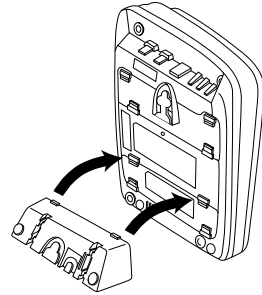

Flip the switch hook tab over so the tab holds the handset.

Raise the antenna.

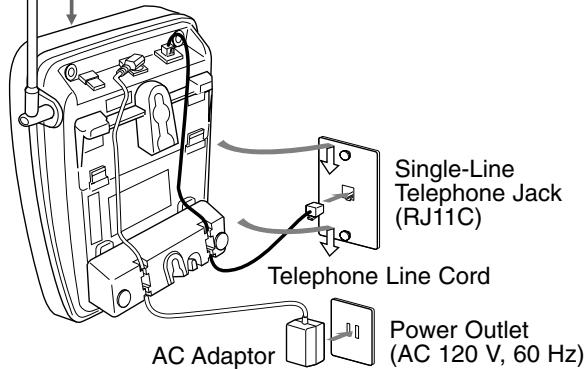

- Route the cords through the guides.
- Place the base unit on the posts of the wall plate and push down until it is firmly seated.
- USE ONLY WITH Supplied AC ADAPTOR (TAC-1700; power source AC 120V, 60 Hz/DC 9V).

### NOTES:

- **Do not use any outlet controlled by a wall switch.**
- **If you don't have a standard wall plate, cut out the template on page 33 and use it to position two screws (minimum length of 1<sup>3</sup>/<sub>8</sub> inches) into the wall with the heads protruding about 1/4 inch.**

# INSTALLATION

## CHARGING THE BATTERY PACK

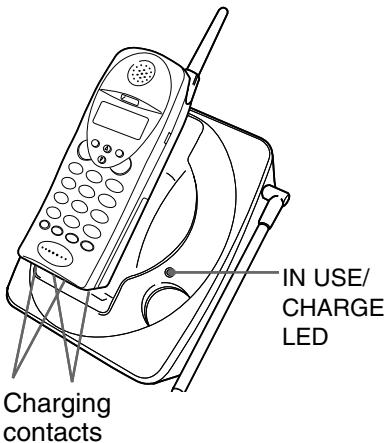
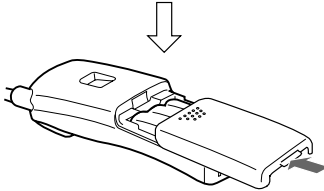
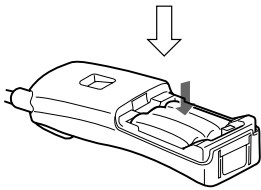
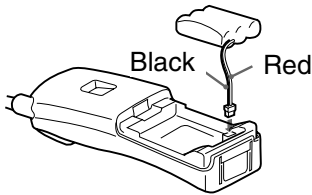

**1** Remove the battery compartment cover on the back of the handset by sliding it down.

**2** Plug the battery pack cord into the connector in the battery compartment by observing the correct polarity. It fits in only one way.

**3** Place the battery pack in the battery compartment.

**4** Put the battery compartment cover back by sliding until it snaps into place. Make sure not to get the wires of the battery pack caught in the cover.

**5** Place the handset on the base unit. Be sure the IN USE/CHARGE LED lights.

If the IN USE/CHARGE LED does not light, make sure the AC adaptor is plugged in securely and that the electrical outlet is working and not controlled by a light switch.

**It is important to charge the battery for 12 to 16 hours continuously without any interruption before you use the handset for the first time.**

### NOTES:

- Use only the supplied battery pack (TRB-8000; power source 600mAh, 3.6VDC)
- The battery pack is not charged properly if the charging contacts are dirty or tarnished. Clean the contacts occasionally with a dry cloth.

# INSTALLATION

After the battery pack is fully charged;

Operation	Approx. battery life
While in use (Talk mode)	up to 6 hours
While not in use (Standby mode)	up to 7 days

When "Low Battery" blinks on the LCD, the battery needs to be charged. Finish the call as soon as possible and place the handset on the base unit.

Low Battery

**NOTE:**

***If a call comes in when the battery is too low to operate properly, you will be unable to answer the call or the call will be disconnected.***

# INSTALLATION

## SETTING THE TONE/PULSE SWITCH

Set the TONE/PULSE switch to TONE.

If the call does not connect with the TONE setting, set the TONE/PULSE switch to PULSE.

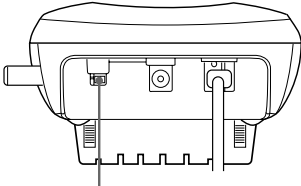

TONE/PULSE switch

## SETTING OR CANCELING THE AUTO TALK FUNCTION

If the handset is placed on the base unit, you can answer a call by simply lifting the handset from the base unit (Auto Talk). If the handset is not on the base unit, you can answer a call by pressing any one of the buttons (Any-key Answer function). When the Auto Talk function is set to ON, the Any-key Answer function is also set to ON.

When the Auto Talk function is set to OFF, you can lift the handset and view the caller ID information before choosing to answer. This function is preset to OFF at the factory prior to shipment.

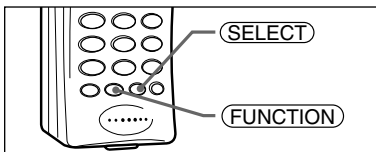

- 1** Press **FUNCTION**. The LCD displays the current setting.
- 2** Press **SELECT**. Each time you press **SELECT**, the On/Off setting will be switched.
- 3** Press **FUNCTION**. The handset is put in standby mode.

```
1▶Auto Talk:Off
2 CIDCW      :0n
3 Area Code:
```

```
1▶Auto Talk:0n
2 CIDCW      :0n
3 Area Code:
```

## SETTING OR CANCELING CALLER ID ON CALL WAITING

This function is preset to ON at the factory so that you will receive caller ID on Call Waiting when subscribing to both local telephone company services.

If you do not subscribe to these services, be sure to set this function to OFF.

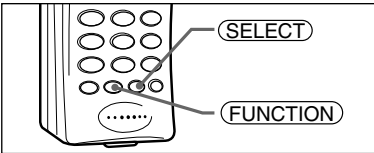

**1** Press **FUNCTION**. The LCD displays the current setting.

```
1▶Auto Talk:Off
2 CIDCW      :0n
3 Area Code:615
```

**2** Press **▼** or **2** to move the pointer to CIDCW and press **SELECT**. Each time you press **SELECT**, the On/Off setting will be switched.

```
1 Auto Talk:Off
2▶CIDCW      :0n
3 Area Code:615
```

**3** Press **FUNCTION** and replace the handset on the base unit.

# INSTALLATION

## SETTING THE AREA CODE

It is necessary to program your area code so that local calls will be properly displayed on caller ID.

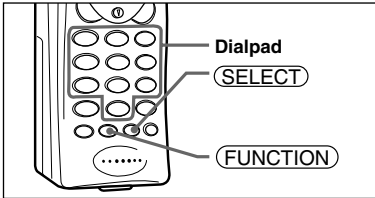

- 1 Press **FUNCTION**. The LCD displays the following message.
- 2 Press **▼** or **3** to move the pointer to Area Code.
- 3 Press **SELECT**.  
Enter a 3-digit area code. For example, enter "615."  
If you enter a wrong number, press **DELETE**.
- 4 Press **SELECT**. A beep sounds and the area code is set.
- 5 Press **FUNCTION**. The handset is put in standby mode.

```
1▶Auto Talk:Off
2 CIDCW      :0n
3 Area Code:
```

```
1 Auto Talk:Off
2 CIDCW      :0n
3▶Area Code:
```

```
1 Auto Talk:Off
2 CIDCW      :0n
3 Area Code:615
```



```
1 Auto Talk:Off
2 CIDCW      :0n
3▶Area Code:615
```

### NOTES:

- *Change your area code when you move to another location that has a different area code.*
- *When you make a call to a number within your area code, only the last 7 digits of the number are dialed. During call-back, however, the phone will include the area code from where the call originated when it automatically redials the number. To avoid this problem, always be sure to set the area code of your phone so that the phone will automatically exclude the area code when the incoming code is the same as that of the phone.*



# INSTALLATION

## CARRYING THE HANDSET IN THE BELT CLIP

You can attach the Belt Clip to the handset in order to carry it on your belt.

### Attaching the Belt Clip to the Handset

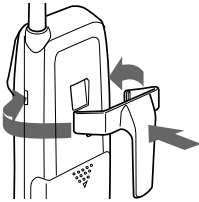

Insert the Belt Clip tabs into the holes on each side of the handset until they click.

**NOTE:**

*Be sure to insert the tabs properly into each hole to prevent the Belt Clip from falling off.*

### Removing the Belt Clip from the Handset

Pull both sides of the Belt Clip to release the tabs from the grooves.

**NOTE:**

*Remove the Belt Clip carefully from the handset, taking care not to hurt your fingers or damage your nails.*

## USING A HEADSET

You can talk with hands-free convenience using an optional headset (part#: RC 008260) that has a 3/32-inch(2.5mm) plug.

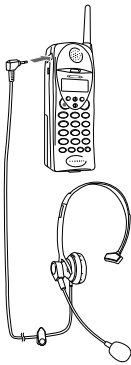

To connect the headset, open the rubber cover on the left side of the handset, then insert the headset's plug into the jack.

With a headset connected, you can make or answer calls as usual using the keys on the handset.

You can use the supplied Belt Clip to hang the handset on your belt for greater convenience.

When you finish using the headset, disconnect it from the handset and close the rubber cover to protect the jack.

**NOTES:**

- *The handset's earspeaker and microphone are turned off with a headset connected.*
- *Pressing the **(VOL)** (**▲**,**▼**) button of the handset also controls the connected headset's volume.*
- *If you place the handset on the base unit while the headset is connected, be sure the handset is placed properly.*

# BASIC OPERATION

## MAKING A CALL

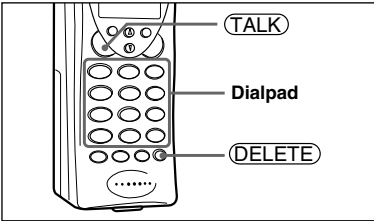

- 1** Key-in the phone number.  
The LCD displays the entered numbers.

1234567890123456  
789

**NOTE:**

*To delete a wrong number, press **DELETE**. To delete all numbers, press and hold **DELETE**.*

- 2** Press **TALK**. “Talk” and the volume setting appears on the LCD.

Talk  
<High>

The number is dialed.

Talk 0:00  
1234567890123456  
789

After about 5 seconds, the LCD displays the duration of the call.

- 3** To hang up, press **TALK** or place the handset on the base unit.

# BASIC OPERATION

## ANSWERING A CALL

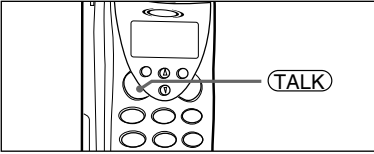

- 1 When a call is received, the phone rings and the LCD displays as shown.

Incoming call

- 2 Press **TALK** to connect.

“Talk” and the volume setting appears on the LCD.

Talk 0:00  
<High>

- 3 To hang up, press **TALK** or place the handset on the base unit.

12:35

## OUT OF RANGE

During a call, as you begin to move too far from the base unit, you first hear a clicking sound. As you travel farther, the noise increases. Then, you should move close to the base unit. If you travel out-of-range, your call terminates.

## CALL WAITING

To use this feature, you must subscribe to the Call Waiting Service.

- 1 When you hear a call-waiting tone while you are already talking on the phone, simply press **FLASH**.
- 2 To take the original call back, press **FLASH** again.

### NOTE:

**Pressing **FLASH** without receiving a Call Waiting signal may disconnect the current caller.**

# BASIC OPERATION

---

## CHANGING THE RINGER VOLUME

Use the following procedure to set the ringer volume of the handset as desired.

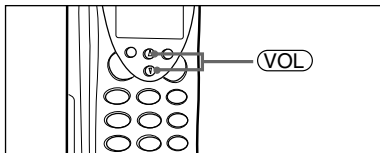

Press **VOL** to select one of four ringer tone and volume combinations during standby mode.

Each time you press **VOL** (▼ or ▲), the LCD will display the setting and the phone will ring using the selected ringer.

## CHANGING THE HANDSET SPEAKER VOLUME

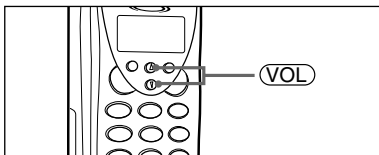

During a telephone call, press **VOL** to select one of four speaker volume levels; Loud, High, Medium or Low.

Each time you press **VOL** (▼ or ▲), the LCD will display the setting.

**NOTE:**

*The volume setting Loud may be too loud because it is set for hearing aid compatibility.*

# BASIC OPERATION

## 3 NUMBER REDIAL

To redial any of the last three numbers dialed from the handset (up to 32 digits):

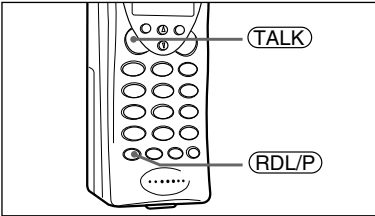

- 1 Press **(RDL/P)** during standby mode.

The last dialed number (Redial 1) appears on the LCD. Each press of **(RDL/P)** will display one of the three numbers dialed.

- 2 Press **(TALK)** when the desired number is displayed.

## SENDING THE TONE SIGNAL

Even if you have PULSE service (the TONE/PULSE switch is set to pulse), you can use this phone with banking and other phone services requiring touch tone signals.

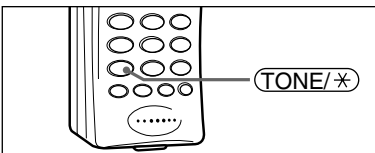

- 1 Dial the service number and wait for the connection.
- 2 Press **(TONE/\*)**, then enter the numbers required.  
You will hear the tones on the line.

# BASIC OPERATION

## PAGING THE HANDSET

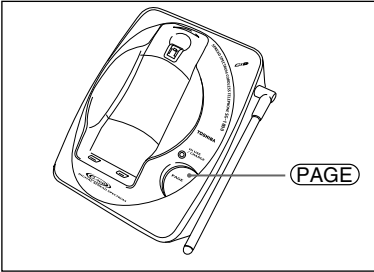

**1** To locate the handset while it is off the base, press **(PAGE)**. The handset beeps for 30 seconds and the LCD displays the following message:

To stop paging, press **(PAGE)** or **(TALK)** twice, or return the handset to the base unit.

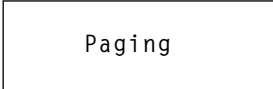

**NOTES:**

- *You cannot page the handset during a call.*
- *Be careful not to close your ear to the ringer on the back side of the handset while paging, because it may be too loud.*

## INTERFERENCE OR STATIC

If you hear noise during a call, press **(CHANNEL)** to select another channel. The LCD displays “Scanning” while changing a channel.

# MEMORY DIALING

You can store up to 20 telephone numbers and their associated names in the memory.

You can program them yourself or transfer them from the Caller ID memory.

## NOTES:

- **Always press a button within 20 seconds after pressing the previous button. Otherwise, the setting procedure will be canceled and the handset is put in standby mode.**
- **If you press a wrong button, an error tone sounds and the handset returns to standby mode.**
- **If you receive an incoming call or a pager call from the base unit or you press **(TALK)** or charge the handset during the operation, the operation will be cancelled.**

## STORING NUMBERS

You can store up to 20 digits including #, \*, and PAUSE as a telephone number, and up to 13 characters as a name in one memory address.

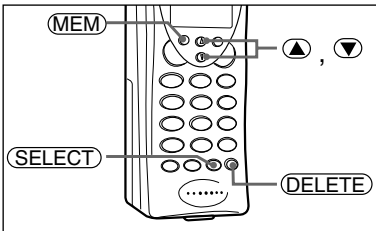

- 1** Pick up the handset and press and hold **(MEM)** till a beep sounds.

The LCD displays the memory dial list beginning the location number 01.

```
Memory Store
01 ▶ SMITH JOHN
02 DOE JOHN
```

- 2** Enter a two-digit number (01-20), or press **(▼)**, **(▲)** to select a free memory location number.

**Example:** Selecting memory location number 07



```
Memory Store
07 ▶
08
```

- 3** Press **(SELECT)**. The LCD displays the following screen.

```
Store Name
```



# MEMORY DIALING

**4** Enter a name of up to 13 characters.

Press  or  repeatedly to enter a space, alphanumeric characters: a space  
→ A → B → ... → Y → Z → a → b → ... y  
→ z → 0 → 1 → 2 ... 9 → \* → # → - → &  
→ ( → ) → a space → A → ...

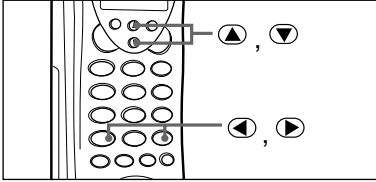
Store Name  
SMITH JOHN



To enter the next character, press .  
To move the cursor to the left, press .  
Or, you can press  to delete the entered character.

**5** Press . The LCD displays the following screen:

Store Number

**6** Enter a telephone number to be stored.

**Example:** Enter "1 PAUSE 1234567890."

Store Number  
1P1234567890

**NOTE:**

*By pressing , you can insert a 2-second pause in the memory dial to make a long distance call or call through a PBX.*

**7** Press . A confirmation beep sounds and the number is stored.

Store Number  
Memory07 Stored

**8** The LCD returns to Memory Store screen.  
To store more name and numbers, return to step 2.  
To finish the operation, press  or return the handset to the base unit.

Memory Store  
07▶SMITH JOHN  
08



# MEMORY DIALING

## DIALING A STORED NUMBER

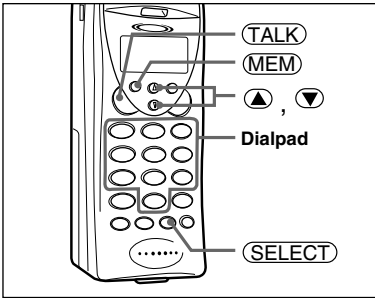

**1** Pick up the handset and press **MEM**.

01	SMITH JOHN
02	DOE JOHN
03	▶MOM AND DAD

**2** Press **▼**, **▲** or enter a two-digit number (01-20) to display the desired destination.

**NOTE:**

To see the stored phone numbers, press **▶**.

If **▶** appears next to the 12th digit, the number is longer than 13 digits. Press **▶** to see the rest of the numbers, and **◀** repeatedly to return to the name display.

When you press **SELECT**, the LCD displays both the name and telephone number.

MOM AND DAD
8175551212

**3** Press **TALK**. The stored number will be dialed.

**NOTE:**

If you press **MEM** while you are selecting a location, memory selection is cancelled and the handset is put in standby mode.

# MEMORY DIALING

## CHANGING AND DELETING STORED NUMBERS

You can delete a number or simply store another one in its place. When you store a new phone number, the data stored in that memory location is deleted automatically.

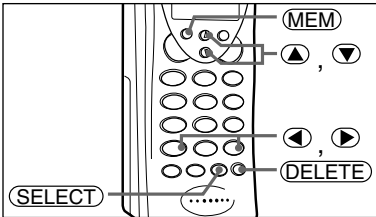

- 1** Pick up the handset and press and hold **(MEM)** till a beep sounds.

Memory Store
01▶SMITH JOHN
02 DOE JOHN

- 2** Enter a two-digit number (01-20) or press **(▼)**, **(▲)** to select the memory location you want to edit/delete.

- 3** Press **(SELECT)**. The LCD displays the Edit/Delete Memory screen.

▶Edit Memory01
Delete Memory01
Go Back

- 4** Press **(▼)** or **(▲)** to select the desired function and press **(SELECT)**. To edit the stored data, select “Edit.” To delete the data, select “Delete.” To return to the previous screen, select “Go Back.”

- 5** To edit data, go to step **a**. To delete data, go to step **b**.

### **a** EDITING THE NAME AND TELEPHONE NUMBER

Use the **(▲)**, **(▼)**, **(◀)**, and **(▶)** buttons to change the name. (See “Storing Numbers” on page 23 for instructions on how to enter names).

# MEMORY DIALING

- (1) Press **(DELETE)** to erase a character at the cursor position.  
The next character on the right moves to the cursor position.

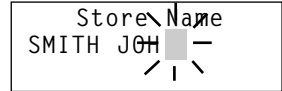

Store Name  
SMITH JOHN

- (2) Press **(SELECT)**. The LCD displays the programmed numbers screen.

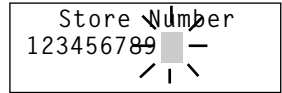

Store Number  
123456789

- (3) Press **(DELETE)** to erase numbers, and enter the correct number.

- (4) Press **(SELECT)**. A confirmation beep sounds and the number is stored. Press **(MEM)** or return the handset to the base unit.

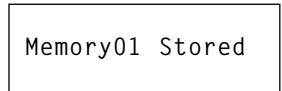

Memory01 Stored

## **b** DELETING THE STORED DATA

- (1) Press **(▲)** or **(▼)** to move the pointer to select **Yes** or **No**.

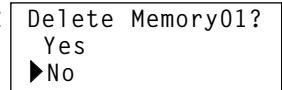

Delete Memory01?  
Yes  
▶No

- (2) Press **(SELECT)** or **(DELETE)**.

If **Yes** is selected: A confirmation beep sounds and the number is erased.

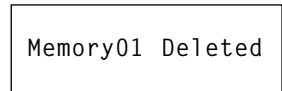

Memory01 Deleted

If **No** is selected: The LCD returns to the programmed names screen.

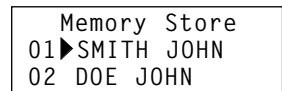

Memory Store  
01▶SMITH JOHN  
02 DOE JOHN

- (3) Press **(MEM)**, or return the handset to the base unit.

# CALLER ID/CALL WAITING

- Before you can take advantage of the Caller ID and Call Waiting features, you must subscribe to these services from your local telephone company.
- Name and number caller ID only work in conjunction with service provided by your local telephone company.

## ANSWERING A CALL WITH CALLER ID SERVICE

**1** When the caller ID message is received, the display shows the caller's phone number along with the date and time. The incoming call information is stored in Caller ID record. If the Caller ID service includes the caller's name, the caller's name appears on the display (up to 15 letters).

Number of calls from the same phone number \_\_\_\_\_  
The date and time received \_\_\_\_\_  
Caller's name \_\_\_\_\_  
Caller's phone number \_\_\_\_\_

5/11 12:30PM 01
SMITH JOHN
123-456-7890

You may receive any one of the following messages;  
When invalid data is received .....Incomplete Data  
When a private name is received .....Private Name  
When a private number is received .....Private Number  
When an unknown name is received .....Unknown Name  
When an unknown number is received .....Unknown Number

**2** When you pick up the phone, the display changes to "Talk"  
(See page 19).

Talk 0:00 <High>
---------------------

### NOTES

- *If you answer a call before the Caller ID message is received (Example before the second ring), the Caller ID message will not appear.*
- *When the call is received via a telephone company that does not offer Caller ID service, the caller's phone number and name do not appear (This includes international calls).*
- *When the call is via a Private Branch eXchange (PBX), the caller's phone number and name may not appear.*
- *Data errors appear as "■".*

# CALLER ID/CALL WAITING

## CALL WAITING

If you want to use the Call Waiting feature, you must subscribe to the Call Waiting service provided by your local telephone company.

The LCD will show another incoming call even if you are currently engaged in a telephone conversation. This feature can be enabled or disabled. If enabled, it informs the user of a new incoming call by generating short beeps at regular intervals until the call is either answered, or the person calling hangs up. With Caller ID on call waiting, you can see who's calling to decide if you want to interrupt your current conversation to answer the incoming call.

## WITH CALLER ID SERVICE

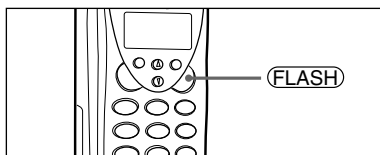

- 1** Before answering a call, check to see that the caller's name and telephone number are displayed on the screen. To switch to the waiting call, press **FLASH** on the handset. The first caller is put on hold.
- 2** To switch back to the first caller, press **FLASH** again.

### NOTE:

*Pressing **FLASH** without having received a Call Waiting signal may disconnect the current line.*

# CALLER ID/CALL WAITING

## SEARCHING CALLER ID MEMORY

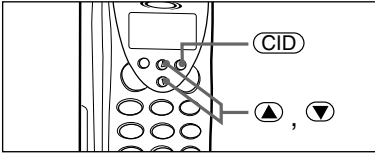

To review who has called your phone, follow the steps below.

The caller ID memory retains a listing of the 50 most recent callers.

**1** Pick up the handset and press **CID**.

If new caller ID data does not exist:

```
Total:02
```

If there is new caller ID data:

```
New :01  
Total:02
```

**2** Press **▼** to display the latest call record.

```
1/7 9:30AM 12  
DOE JOHN  
555-2563
```

If there is no more caller ID data when you press **▼**, the LCD displays the following message.

```
End
```

**3** Press **CID** to return to standby mode.

# CALLER ID/CALL WAITING

## DIAL OUT

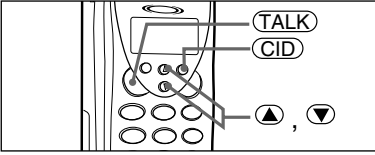

- 1** Pick up the handset and press **(CID)**. Then, press **(▽)** or **(▲)** to display the number you wish to dial.

1/7	9:30AM 12
SMITH JOHN	
456-7890	

- 2** Press **(TALK)**.  
The displayed number will be dialed.

TALK
4567890

### NOTE:

*To enter a number for a long distance call, see "EDITING CALLER ID DATA" page 32. It is not necessary to add a "1" when dialing some area codes. If in doubt, check your local telephone directory.*

# CALLER ID/CALL WAITING

## EDITING CALLER ID DATA

You can edit the Caller ID data.

- 1 Pick up the handset and press **(CID)**. Then, press **(▼)** or **(▲)** repeatedly to display the Caller ID data you want to edit.

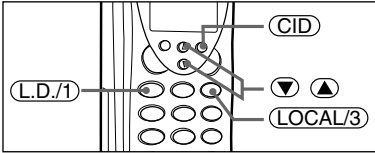

- 2 Press **(L.D./1)** for a long distance call prefix "1" and **(LOCAL/3)** for area code setting and cancellation.

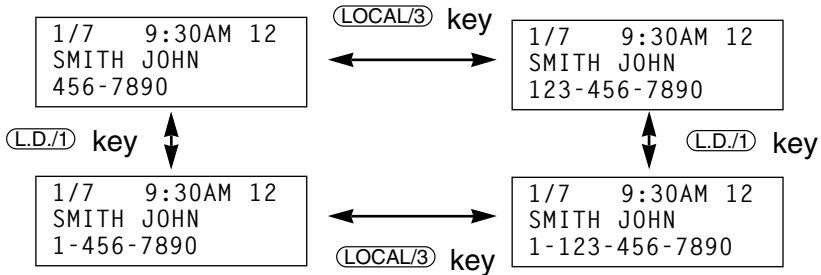

- 3 After editing Caller ID data, you can continue with dialing out or storing procedures.

To dial out, press **(TALK)** (page 31).

To store into memory dial, press **(MEM)** (page 33).



# CALLER ID/CALL WAITING

## STORING TO SPEED DIAL MEMORY

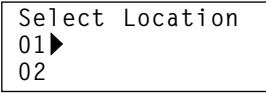
- 1 Pick up the handset and press **(CID)**. Then, press **(▼)** or **(▲)** to bring up the number you wish to store into Speed Dial memory.
- 2 Press **(MEM)**.  
The LCD displays the following screen.

```
Select Location
01▶
02
```
- 3 Enter a two-digit number (01-20) or press **(▼)**, **(▲)** to select memory location.
- 4 Press **(SELECT)**. A confirmation beep sounds and the Caller ID data is stored. Press **(CID)** to return to standby mode.

### If you select a memory location which is already stored:

(1) The LCD displays the following prompt:

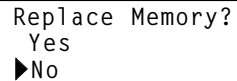

```
Replace Memory?
Yes
▶No
```

(2) Press **(▲)** to select **Yes** and press **(SELECT)**.

A confirmation beep sounds and the new data overwrites the old data. The LCD returns to the Caller ID display screen.

### If you select **No** :

The LCD returns to the Caller ID display screen.  
Press **(CID)** to return to standby mode.

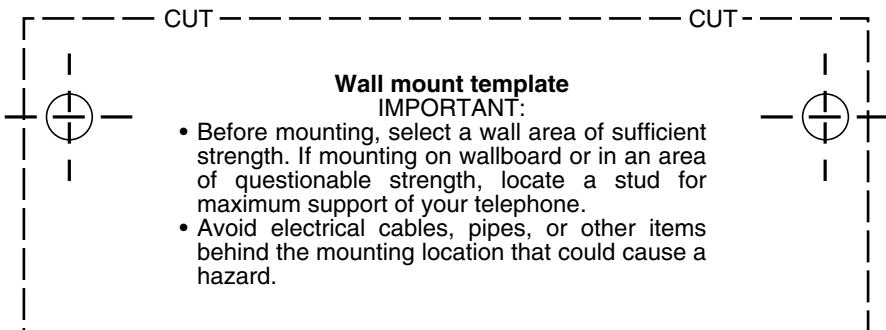

# CALLER ID/CALL WAITING

## DELETING CALLER ID DATA

### DELETE INDIVIDUAL CALLER ID DATA:

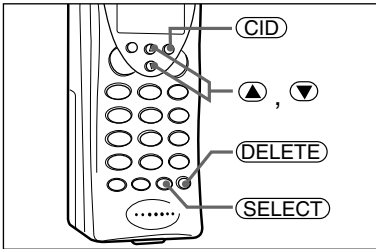

**1** Pick up the handset and press **CID**. Then, press **▼** or **▲** to display the caller ID number you wish to delete from the memory.

**2** Press **DELETE**.  
Press **▲** or **▼** to select Yes or No.

Delete Message?
▶Yes
No

**3** Press **SELECT** or **DELETE**. If you select **Yes**, confirmation beeps are emitted and the LCD displays the next caller ID data. If there is no more caller ID data, the LCD displays the message "End."

If you select **No**, the LCD returns to the Call ID data screen.

**4** Press **CID** to return to standby mode.

# CALLER ID/CALL WAITING

## DELETE ALL CALLER ID DATA:

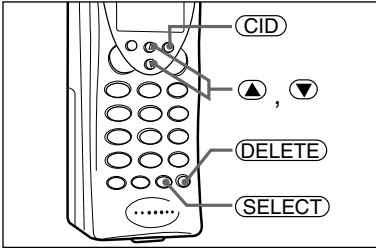

**1** Press **CID**. The LCD displays the following screen.

```
New :01
Total:02
```

**2** Press **DELETE**.  
Press **▲** or **▼** to select Yes or No.

```
Delete All?
Yes
▶No
```

**3** Press **SELECT** or **DELETE**.

If you select **Yes**, a confirmation beep sounds and the LCD displays the total number of items "00".

```
Total:00
```

If you select **No**, the LCD returns to the screen indicating the number of Caller ID calls.

```
New :01
Total:02
```

**4** Press **CID** to return to the standby mode.

# TROUBLESHOOTING

Should any problem occur with the set, use the following simple tests to determine whether or not servicing is required.

PROBLEM	SOLUTION
<p>No dialtone. No calls come in.</p>	<ul style="list-style-type: none"> <li>• The AC adaptor of the base unit is disconnected. → Plug the AC adaptor into the base unit and the AC 120V outlet.</li> <li>• The battery is low. → Place the handset on the base unit to recharge.</li> <li>• Telephone line cord is disconnected. → Check both ends of the telephone jack.</li> <li>• The previous call is not disconnected. → Press <b>(TALK)</b> to disconnect the line.</li> <li>• Trouble with the telephone line. → Check an extension line.</li> <li>• Outlet used is controlled by a wall switch in its OFF position. → Relocate it to another outlet.</li> <li>• The digital security code is changed. → Disconnect the power and remove the handset. After a few seconds, restore the power and place the handset on the base unit for at least 3 seconds.</li> <li>• The handset is too far from the base unit. → Bring the handset near the base unit.</li> </ul>
<p>Noise or interference.</p>	<ul style="list-style-type: none"> <li>• The handset is too far from the base unit. → Bring the handset near the base unit.</li> <li>• The battery is low. → Place the handset on the base unit to recharge.</li> <li>• The base unit is located in a place with high interference. → Relocate it to another outlet.</li> <li>• Interference from TV, appliances, etc. → Press <b>(CHANNEL)</b> to select a clearer channel, or relocate the base unit.</li> <li>• There may be line noise. → Check with another telephone.</li> <li>• The volume control is set too high. → Reduce volume to a lower setting.</li> <li>• The base antenna is not in a vertical position. → Lift the antenna to a vertical position.</li> </ul>
<p>Battery pack goes low quickly.</p>	<ul style="list-style-type: none"> <li>• The battery pack was not fully charged at the initial charging. → Charge the battery pack for 12 to 16 hours without any interruption.</li> <li>• The battery is several years old → Replace with a new battery</li> </ul>

# TROUBLESHOOTING

PROBLEM	SOLUTION
The handset battery pack does not charge.	• The battery is not installed correctly. → Install the battery pack correctly.
	• The charging contacts of the handset and base are not clean. → Clean them with a dry cloth.
	• The battery is several years old. → Replace with a new battery.
The unit operates abnormally.	• The phone needs to be reset. → Disconnect the AC adaptor and reconnect it after a few seconds.
“Low battery” blinks on the display. The operation is stopped.	• The battery is low. → Recharge the battery.
When the handset is returned to the base unit with the volume level set at Loud, a momentary squeal or howling sound may sometimes be heard.	• This is normal. → It may be prevented by changing the volume setting to High, Medium or Low before returning the handset to the base unit
The phone does not display the Caller ID/Caller ID on Call Waiting data.	• You have to subscribe to Caller ID/Caller ID on Call Waiting services. → Check with your local telephone company.
	• You answered the call before Caller ID data is received. → Let the phone ring twice before you answer the call.

# WARRANTY/SERVICE

---

## SERVICE REQUIREMENTS

If the cordless telephone should malfunction, or need changes or modifications, all repairs will be performed by an authorized Toshiba Service Station. This unit has been registered with the FCC for direct connection to the telephone network. Under the FCC program, no customer is authorized to repair this unit. This applies to units either in or out of warranty. If an unauthorized repair is performed, the registration of the unit for direct connection to the network will be null and void. If the unit is still in warranty, the remainder of the warranty period will also be null and void.

It is the responsibility of users requiring service to report the need for service to the Toshiba dealer.

## IMPORTANT INSTRUCTIONS TO USERS

Your telephone equipment has been designed and constructed to conform to federal regulations and can be connected to the phone line as described in this manual.

Please note that each product connected to the telephone line places a certain load on the line. We designate this as the unit's "Ringer Equivalence Number."

It is most unlikely, but...If your telephone equipment should cause problems on the phone line, the phone company has the right to temporarily discontinue your service. If this happens, the phone company will notify you and give you the opportunity to correct the problem. Also, you need to know that the phone company does have the right to make changes in their lines and/or equipment.

If these changes might affect your telephone equipment (or require changes in the telephone equipment or its connection), the phone company will notify you in writing, so you have the chance to take whatever action necessary to ensure uninterrupted phone service.

## FCC REQUIREMENTS

You are no longer required by the FCC to notify your local telephone company of your intent to connect a new telephone. Your local telephone company may call you and request information about your phone such as: the brand name, model number, registration number, and ringer equivalence number. This information is provided on a label located at the bottom of the base unit and handset.

You may not directly connect your telephone equipment to coin telephone services. Check with your local telephone company if you wish to connect your telephone equipment to a party line service. Some party line services require a special adaptor or modification to your telephone.

It should be noted that some cordless telephones operate at frequencies that may cause interference to nearby TVs and VCRs; to minimize or prevent such interference, the base of the cordless telephone should not be placed near or on top of a TV or VCR; and, if interference is experienced, moving the cordless telephone farther away from the TV or VCR will often reduce or eliminate the interference.

# WARRANTY/SERVICE

## TELEPHONE/TELEPHONE ANSWER MACHINE LIMITED WARRANTY

Toshiba America Consumer Products, Inc. ("TACP") and Toshiba Hawaii, Inc. ("THI") make the following limited warranties. These limited warranties extend to the original consumer purchaser or any person receiving this set as a gift from the original consumer purchaser and to no other purchaser or transferee.

### Limited One(1) Year Warranty of Labor and parts

TACP/THI warrant this product and its parts against defects in materials or workmanship for a period of one(1) year after the date of original retail purchase. During this period, TACP/THI will repair or replace your defective product with a new or refurbished unit at our option.

### Owner's Manual

You should read the owner's manual thoroughly before operating this product.

### Your Responsibility

The above warranties are subject to the following conditions.

- (1) You must provide a copy of your bill of sale or other proof of purchase.
- (2) These warranties are effective only if the product is purchased and operated within the USA or Puerto Rico.

(3) Within the continental U.S.A., if you should find a defective product within the warranty period please call 1-877-644-7373.

(4) Warranties extend only to defects in materials or workmanship as limited above and do not extend to any product or parts which have been lost or discarded by you, or to damage to products or parts caused by misuse, accident, damage caused by Acts of God, such as lightning or fluctuations in electric power, improper installation, improper maintenance or use in violation of instructions furnished by us; or to units which have been altered or modified without authorization of TACP/THI, or to damage to products or parts thereof which have had the serial number removed, altered, defaced or rendered illegible.

(5) Physically damaged products are not acceptable for repair or exchange within or after the warranty period expires.

### How to Obtain Warranty Service

In the event a problem should develop with your product, please proceed as follows;

**In The Continental United States contact:**    **In Hawaii contact:**

**[www.toshiba.com/tacp](http://www.toshiba.com/tacp)**

Toshiba Hawaii, Inc.  
327 Kamakee Street,  
Honolulu, HI 96814  
(808)-591-8377

All warranties implied by state law, including the implied warranties of merchantability and fitness for a particular purpose, are expressly limited to the duration of the limited warranties set forth above. With the exception of any warranties implied by state law as hereby limited, the foregoing warranty is exclusive and in lieu of all other warranties, guarantees, agreements and similar obligations of manufacturer or seller with respect to the repair or replacement of any parts. In no event shall TACP/THI be liable for consequential or incidental damages.

No person, agent, distributor, dealer or company is authorized to change, modify or extend the terms of these warranties in any manner whatsoever. The time within which an action must be commenced to enforce any obligation of TACP/THI arising under the warranty or under any statute, or law of the United States or any state thereof, is hereby limited to ninety(90) days from the date you discover, or should have discovered, the defect. This limitation does not apply to implied warranties arising under state law.

This warranty gives you specific legal rights and you may also have other rights which may vary from state to state. Some states do not allow limitation on how long an implied warranty lasts, when an action may be brought, or the exclusion or limitation of incidental or consequential damages, so the above provisions may not apply to you.

# QUICK REFERENCE GUIDE

**TOSHIBA**

**CALLER ID CORDLESS TELEPHONE**  
**SG-1600**  
**SG-1800**

Read the Owner's Manual for details.

## SETTING UP THE BASE UNIT

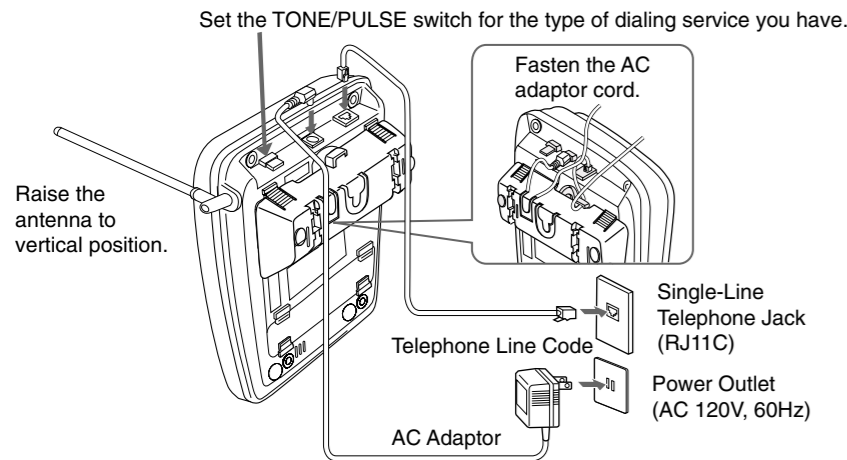

## CHARGING THE BATTERY PACK

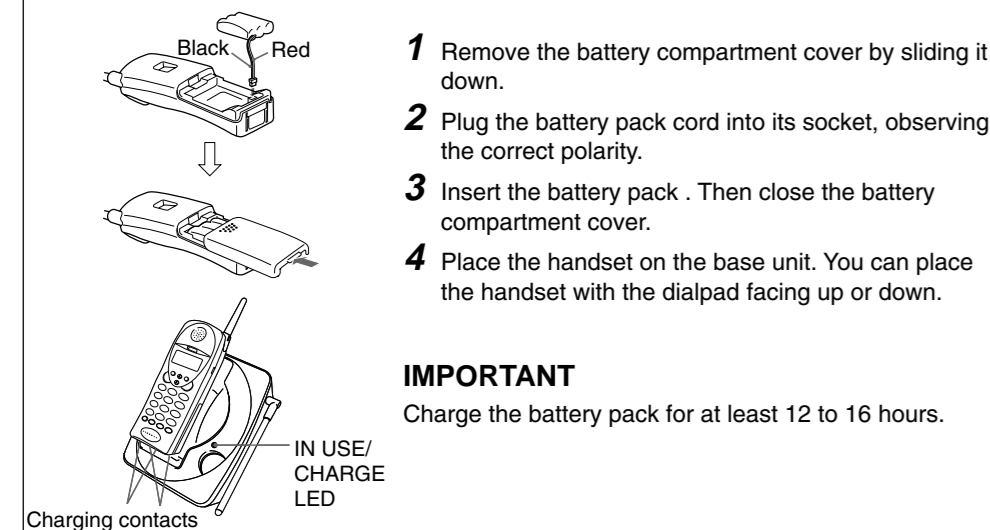

- 1 Remove the battery compartment cover by sliding it down.
- 2 Plug the battery pack cord into its socket, observing the correct polarity.
- 3 Insert the battery pack. Then close the battery compartment cover.
- 4 Place the handset on the base unit. You can place the handset with the dialpad facing up or down.

**IMPORTANT**  
 Charge the battery pack for at least 12 to 16 hours.

## SETTING THE AREA CODE

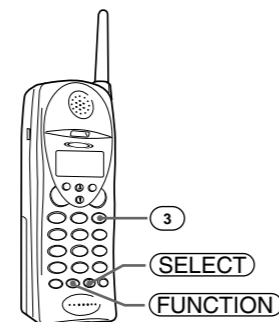

- 1 Press **FUNCTION**, then press **3**.
- 2 Press **SELECT** and enter a 3-digit area code.
- 3 Press **SELECT**, then press **FUNCTION**.

## MAKING A CALL

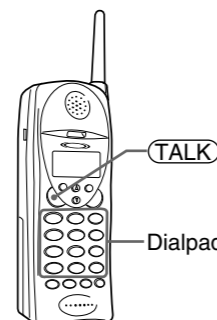

- 1 Key-in the phone number (max. 32 digits).
- 2 Press **TALK**.
- 3 To hang up, press **TALK** or place the handset on the base unit.

## ANSWERING A CALL



- 1 When a call is received, "Incoming call" appears on the LCD.
- 2 Press **TALK** to connect.
- 3 To hang up, press **TALK** or place the handset on the base unit.

## CALLER ID SERVICE

### Making a call with Caller ID data

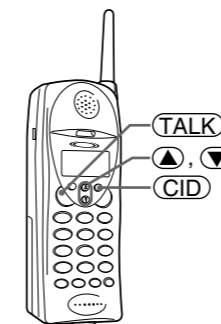

- 1 Press **CID**, then press **▼** or **▲** to display the number you wish to dial.  
 1/7 9:30AM 12  
 SMITH JOHN  
 456-7890
- 2 Press **TALK**.  
 The displayed number will be dialed.  
 TALK  
 4567890

**Note:**  
 For long distance calls, you need a prefix "1" and the area code. Press **L.D./1** and **LOCAL/3** to add "1" and the area code before press **TALK**.

### Storing Caller ID data to Speed dial memory

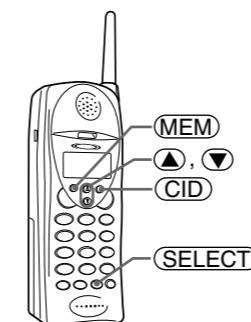

- 1 Press **CID**, then press **▼** or **▲** to bring up the number you wish to store into Speed dial memory.
- 2 Press **MEM**. "Select Location" appears on the LCD.
- 3 Press **▼**, **▲** or enter a memory location number on the dialpad.
- 4 Press **SELECT**. A confirmation beep sounds and the Caller ID data is stored. Press **CID** to return to standby mode.

To use this feature, you must subscribe to the Caller ID service provided by your telephone company.

### Deleting Caller ID data

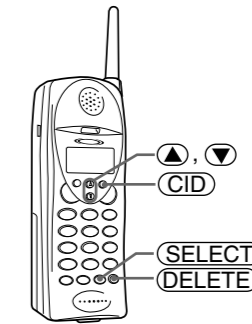

- 1 Press **CID**, then press **▼** or **▲** to display the Caller ID number you wish to delete from the memory.
- 2 Press **DELETE**.  
 Press **▲** or **▼** to select Yes or No.  
 Delete Message?  
 ▶Yes  
 No
- 3 Press **SELECT** or **DELETE**. If you select Yes, a confirmation beep is emitted and the LCD displays the next Caller ID data. If there is no more Caller ID data, the LCD displays the message "END". If you select No, the LCD returns to the Caller ID data screen.
- 4 Press **CID** to return to standby mode.

### Caller ID on Call Waiting

To use this feature, you must subscribe to the Caller ID on Call Waiting service provided by your telephone company.

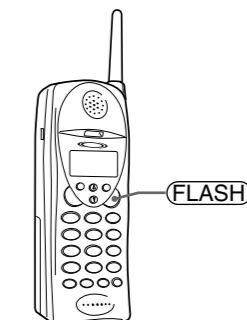

- 1 Before answering a call, check to see that the caller's name and telephone number are displayed on the screen. To switch to the waiting call, press **FLASH**.  
 The first caller is put on hold.
- 2 To switch back to the first caller, press **FLASH** again.



## REFERENCIA RÁPIDA

**TOSHIBA**

CALLER ID CORDLESS TELEPHONE  
SG-1600  
SG-1800

Para los detalles, lea el manual de instrucciones (en inglés).

## INSTALACIÓN DE LA UNIDAD BASE

Ajuste el selector de tono/pulso (TONE/PULSE) al tipo de servicio que posea.

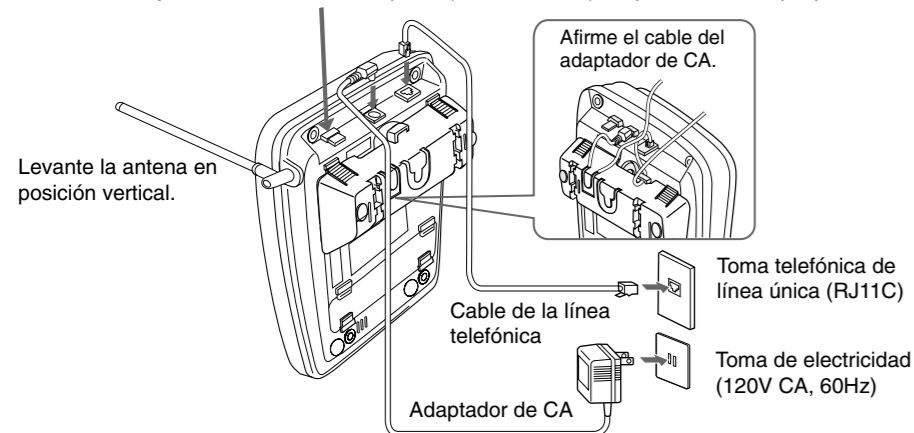

## CARGA DE LA BATERÍA

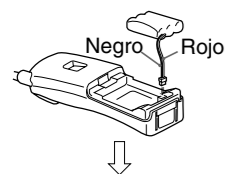

- 1 Quite la tapa del compartimiento de la batería deslizándola hacia abajo.
- 2 Conecte el cable de la batería en el enchufe, observando la polaridad correcta.
- 3 Inserte la batería. Luego cierre la tapa del compartimiento de la batería.
- 4 Coloque el microteléfono sobre la unidad base. Usted podrá colocar el microteléfono con el teclado de marcación encarado hacia arriba o abajo.

### IMPORTANTE

Cargue la batería durante 12 a 16 horas como mínimo.



## AJUSTE DEL CÓDIGO DE ÁREA

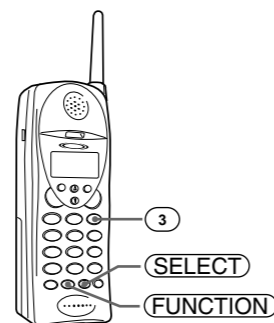

- 1 Presione **FUNCTION**, después presione **3**.
- 2 Presione **SELECT** e introduzca un código de área de 3 dígitos.
- 3 Presione **SELECT**, después presione **FUNCTION**.

## REALIZACIÓN DE LLAMADAS



- 1 Marque el número de teléfono (32 dígitos como máx.)
- 2 Presione **TALK**.
- 3 Para colgar, presione **TALK** o vuelva a colocar el microteléfono sobre la unidad base.

## CONTESTACIÓN DE LLAMADAS



- 1 Cuando se reciba una llamada, en el visualizador de cristal líquido aparecerá "Incoming call".
- 2 Presione **TALK** para conectarse.
- 3 Para colgar, presione **TALK** o vuelva a colocar el microteléfono sobre la unidad base.

## SERVICIO DE IDENTIFICACIÓN DEL QUE LLAMA

### Realización de llamadas con los datos de identificación del que llama

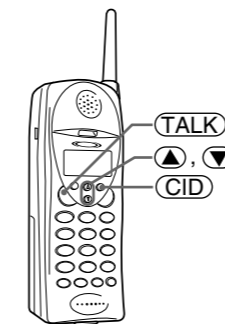

- 1 Presione **CID**, después presione **▲** o **▼** para visualizar el número que desee marcar.
- 2 Presione **TALK**. El número visualizado se marcará.

### Nota:

Para llamadas de larga distancia, necesitará fijar de antemano "1" y el código de área. Presione **L.D./1** y **LOCAL/3** para añadir "1" y el código de área antes de presionar **TALK**.

### Almacenamiento de datos de identificación del que llama para la memoria de marcación rápida

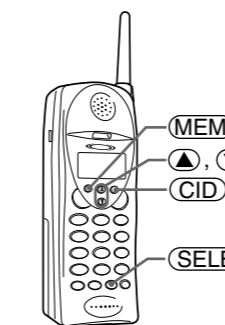

- 1 Presione **CID**, después presione **▲** o **▼** para que aparezca el número que desee almacenar en la memoria de marcación rápida.
- 2 Presione **MEM**. En el visualizador de cristal líquido aparecerá "Select Location" (Seleccione la ubicación).
- 3 Presione **▲**, **▼** o introduzca un número de asignación de la memoria en el teclado de marcación.
- 4 Presione **SELECT**. Sonará un pitido de confirmación y el dato de identificación del que llama se almacenará. Presione **CID** para volver al modo de espera.

Para utilizar esta función, deberá suscribirse al servicio de identificación del que llama provisto por su compañía telefónica.

### Borrado de un dato de identificación del que llama

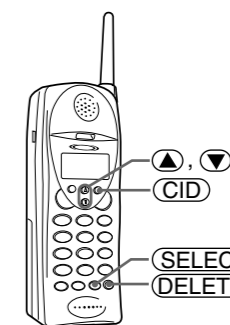

- 1 Presione **CID**, después presione **▲** o **▼** para visualizar la identificación del que llama cuyo número desee borrar de la memoria.
- 2 Presione **DELETE**. Presione **▲** o **▼** para seleccionar Yes (sí) o No.
- 3 Presione **SELECT** o **DELETE**. Si selecciona Yes, se emitirá un pitido de confirmación y el visualizador de cristal líquido mostrará el próximo dato de identificación del que llama. Si no hay más datos de identificación del que llama, en el visualizador de cristal líquido aparecerá el mensaje "END". Si selecciona No, el visualizador de cristal líquido volverá a la pantalla de datos de identificación del que llama.
- 4 Presione **CID** para volver al modo de espera.

### Identificación del que llama con la llamada en espera

Para utilizar esta función, deberá suscribirse al servicio de identificación del que llama con la llamada en espera provisto por su compañía telefónica.

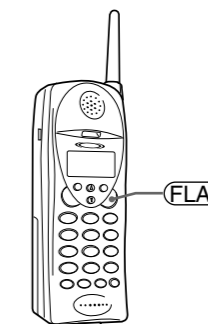

- 1 Antes de contestar a una llamada, compruebe que el nombre del que llama y el número de teléfono están visualizados en la pantalla. Para cambiar a la llamada en espera, presione **FLASH**. La primer llamada se pondrá en espera.
- 2 Para volver a la primer llamada, presione otra vez **FLASH**.

**For technical assistance, purchase of accessories  
or service, please access [www.toshiba.com/tacp](http://www.toshiba.com/tacp).**

**IMPORTANT**

We suggest you record the following information and retain for your records along with your bill of sale or equipment document.

**Model no.** \_\_\_\_\_ **Serial no.** \_\_\_\_\_

**Purchase date** \_\_\_\_\_ **Dealer** \_\_\_\_\_

**Dealer address** \_\_\_\_\_

© 2000 TOSHIBA AMERICA CONSUMER PRODUCTS, INC.